

Dynapac CC900

Double drum vibratory rollers

Atlas Copco





Technical data

 Masses	
Max. operating mass	1,665 kg
Operating mass (incl. ROPS)	1,600 kg
Module mass (front/rear)	750/850 kg

 Traction	
Speed range (Dual/TC/AS)	0-9 km/h
Vertical oscillation	±13°
Theor. gradeability	40 %

 Compaction	
Centrifugal force	17 kN
Nominal amplitude	0.4 mm
Static linear load (front/rear)	8.3/9.4 kg/cm
Vibration frequency	70 Hz
Water tank	110 l

 Engine	
Manufacturer/Model	Kubota D1105-E4B T4f
Type	Water cooled diesel
Rated power, SAE J1995	18 kW (24 hp) @ 2,800 rpm
Fuel tank capacity	23 l

 Hydraulic system	
Driving	Axial piston pump with variable displacement and servo. 2 radial piston motors with constant displacement.
Vibration	Gear pump/motors with constant displacement.
Steering	Gear pump with constant displacement.
Service brake	Hydrostatic in forward and reverse lever.
Parking/ Emergency brake	Failsafe brake in both drums.

Find us locally at www.atlascopco.com

We reserve the right to change specifications without notice. Photos and illustrations do not always show standard versions of machines. The above information is a general description only, all informations are supplied without liability.

Dynapac CC900

Double drum vibratory rollers

Atlas Copco

Technical data

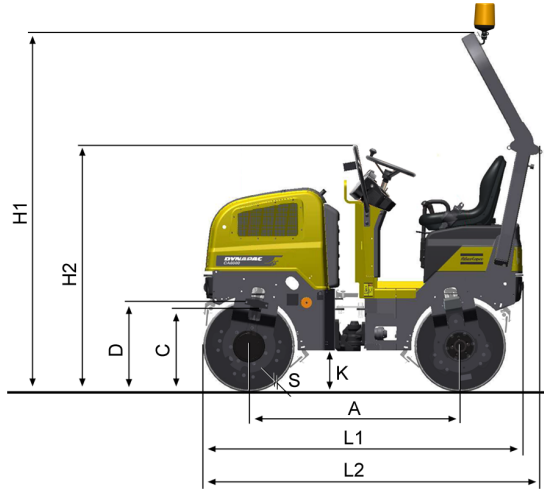

Dimensions	
A. Wheelbase	1,350 mm
B. Width	970 mm
C. Curb clearance	465 mm
D. Drum diameter	584 mm
H1. Height, with ROPS/cab	2,300 mm
H2. Height, w/o ROPS/cab	1,585 mm
K. Ground clearance	255 mm
L1. Length	2,040 mm
L2. Length (ROPS)	2,095 mm
O1. Overhang, right	35 mm
O2. Overhang, left	35 mm
R1. Turning radius, outside	2,810 mm
S. Drum shell thickness	13 mm
W. Drum width	900 mm
α . Steering angle	$\pm 34^\circ$

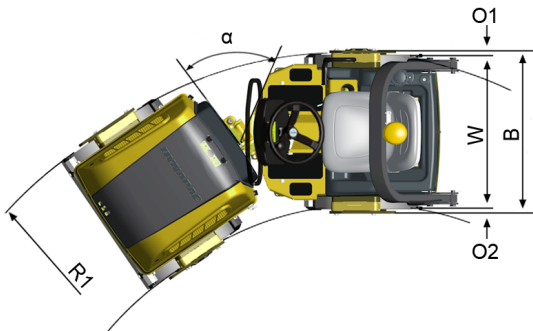

Find us locally at www.atlascopco.com

We reserve the right to change specifications without notice. Photos and illustrations do not always show standard versions of machines. The above information is a general description only, all informations are supplied without liability.

rce_cc900_en-20140430.145521.pdf 2014-04-30 14:55